

SDL550 10W Data/Video Wireless Transceiver

- TDD OFDM full duplex wireless transceiver for video and data Link
- Up to 30Mbps Iperf Throughput @20MHz channel
- Supports Point-to-Point and Point-to-Multipoint Networks
- Interface through web browser or control uart
- 2 Ethernet and 3 channel RS232 data link
- Audio in/out supported by inside Audio codec
- Long distance wireless transceiver with 10W RF power

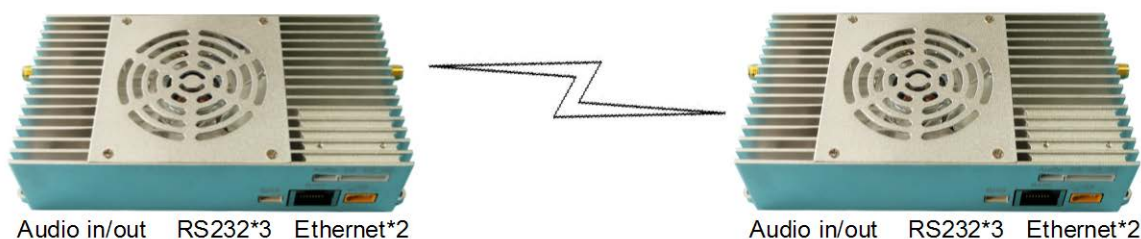

Sihid SDL550 was designed for video and data wireless transmission with two way wireless data link. This OFDM radio device works at 800MHz or 1.4GHz bands, with frequency hopping technology (FHSS) to make sure better stability signal communication.

Features:

- TDD OFDM modulation
- Supports 806~826MHz band or 1428~1448MHz band
- Supports FHSS inside each band
- 1.4/3/5/10/20MHz band widths
- Maximum 30Mbps@20MHz throughput
- RF transmission maximum power: 10W(40 to 42dBm)
- Constellation: QPSK, 16QAM, 64QAM, self-adaption
- Sensitivity: -108dBm(1Mbps)
- Supports IP data transmission(2 Ethernet port)
- Supports serial data transmission(3 channel, RS232)
- Support audio in and audio out with inside audio codec circuit
- 1~15km(ground-to-ground), 30~150km(UAV-to-ground, optional distance grade)
- Web UI and control uart for management
- AES128 encryption
- Uplink and downlink stream control
- Networking mode: Point-to-Point, Point-to-Multipoint, Relay, and Mesh(specify)
- Movement Speed: Supports no less than 120km/h
- Compact size and light weight
- Rugged aluminum alloy housing
- Power input: 24~30V, 28V as default, minimum 2.8A@28V power current rating
- Power consumption <40W(RF Power 10W)
- Dimensions: 124*67.8*28.5mm
- Weight: 252g

Specification

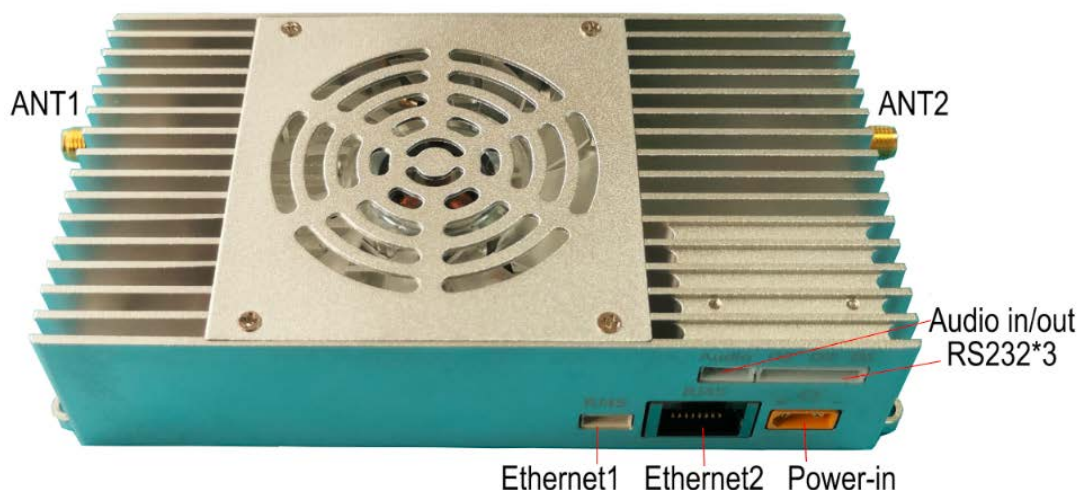

I/O	Description
Ethernet1	4Pin ZH1.5mm connector, bridged with Ethernet2
Ethernet2	RJ45 connector, bridged with Ethernet1
RS232*3	9PIN ZH1.5mm connector, 3 channel RS232 uart
Audio in/out	4PIN ZH1.5mm connector, audio in and audio out port
Power in	XT30PW-M connector
ANT1	Tx/Rx Antenna port, SMA female
ANT2	Rx Antenna port, SMA female

I/O Signal

Ethernet 1

Ethernet 1 is bridged connection with Ethernet 2 on board inside the device. It's a 4PIN ZH1.5mm connector.



Ethernet 2

Ethernet 2 is bridged connection with Ethernet 1 on board inside the device. It's a RJ45 connector.

IP camera video can be connected with SDL550 directly via Ethernet port. HDMI/SDI/AHD/AV camera video can be encoded with Sihid SE10 device and then work with SDL550 via Ethernet connection.

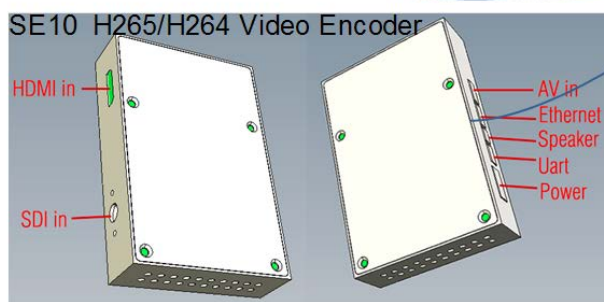

Data uart

9 PIN ZH1.5mm connector, 3 channel RS232 uart. D1 uart data is wireless transmitted via link layer protocol. D2 and D3 uart is wireless transmitted via IP protocol. Baud rate of the three uart and wireless transmitting mode of D2/D3 can be setup by web UI. D3 uart is multiplexed as control uart too.

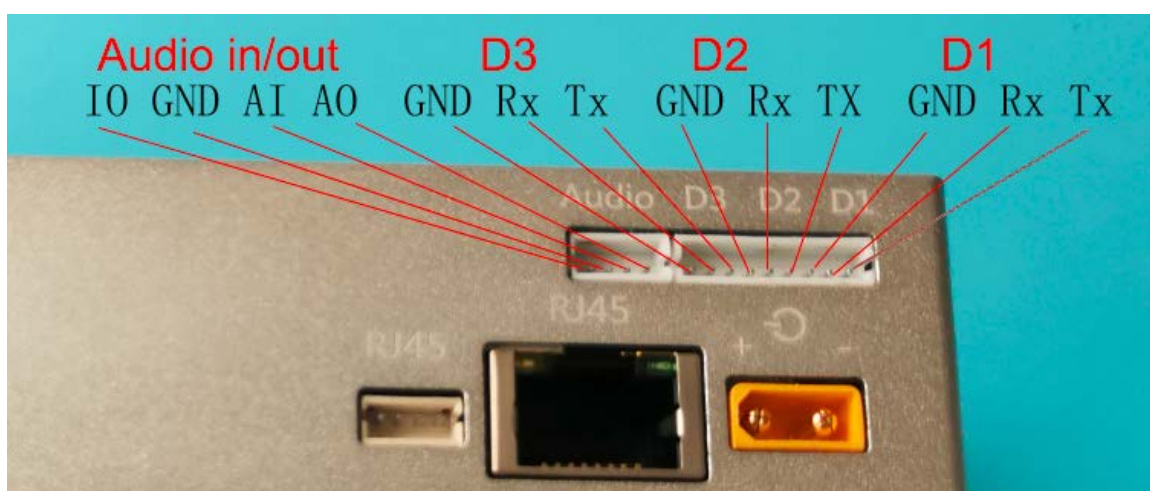

Audio in/out port

4 PIN ZH1.5mm connector, please view up-photo of the pin signal definition. When use two SDL550 devices for point-to-point communication, this port can be used as two-way audio communication.

PIN	Description
IO	Control signal for audio input On/Off switch
GND	GND
AI	Mic in
AO	Line out (drive earphone)

LEDs

Power LED, red light on normal powered;
Node LED, blue light for Node type indicator. Continuous light when the device worked as Control Node, blink light when the device worked as Access Node;
Link LED, wireless link working status indicator as below description:

Link LED	Wireless link status
No light	This node is not connected with the wireless network.
Red light	This node is connected with the wireless network, the wireless link signal is weak.
Orange light	This node is connected with the wireless network, the wireless link signal is in middle.
Green light	This node is connected with the wireless network, the wireless link signal is strong.

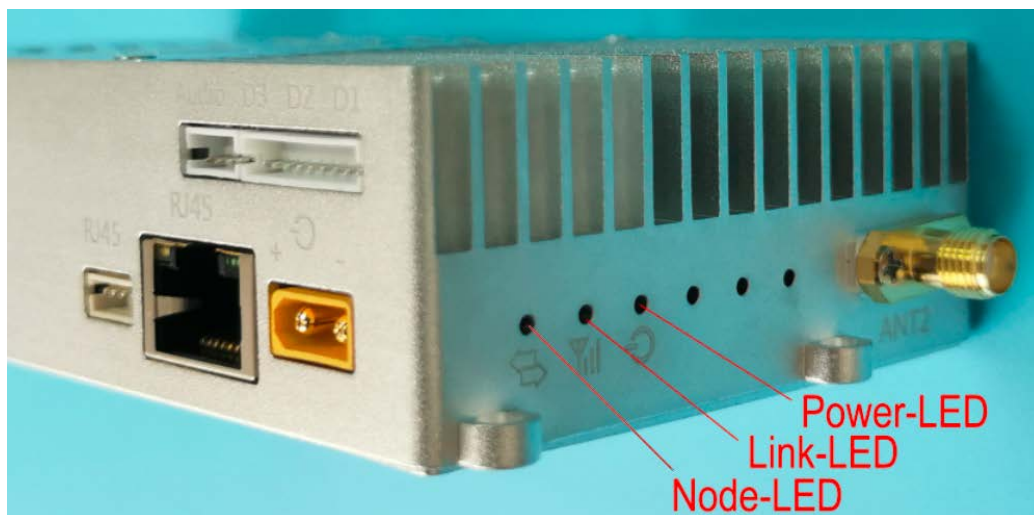

SDL550 device size

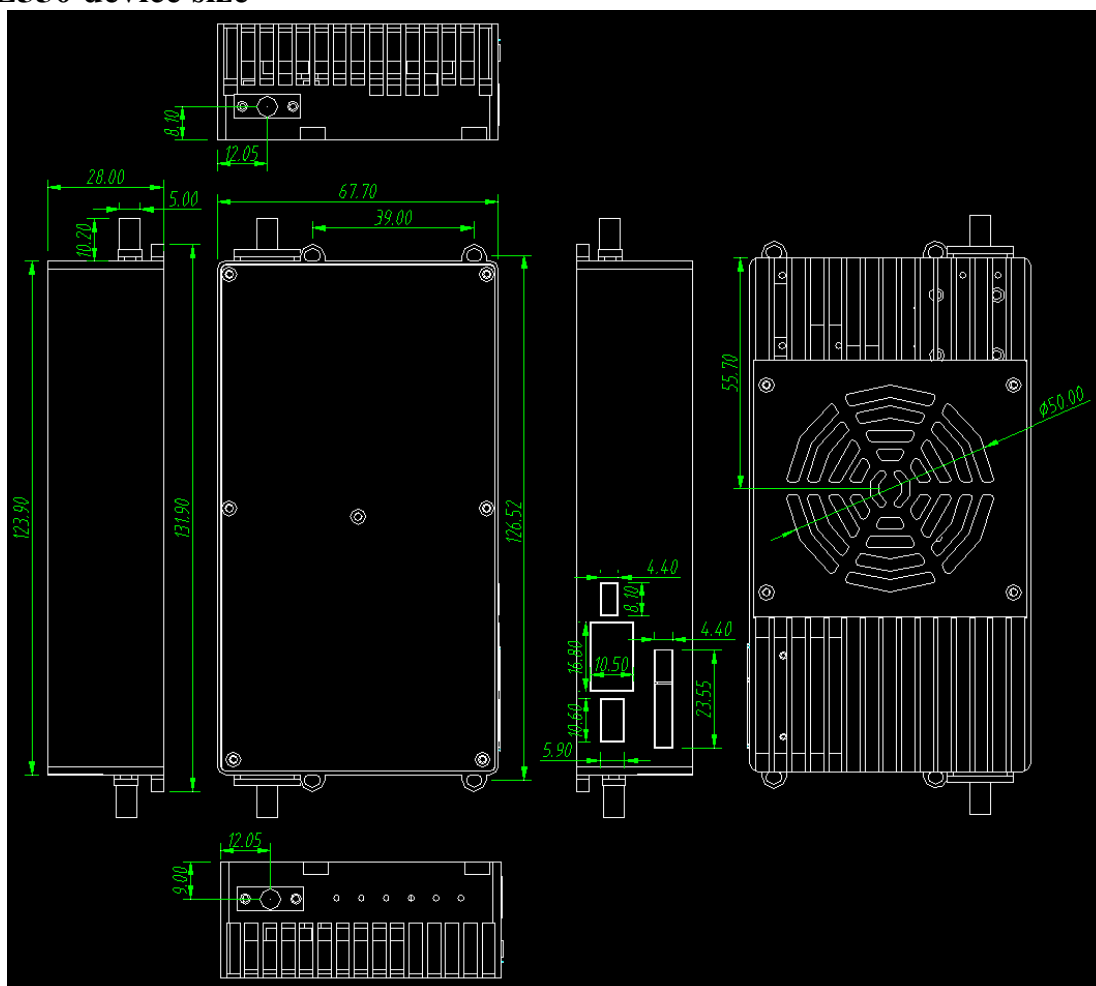

Wireless networking with SDL550

SDL550 supports two operating modes: Access Node or Central Node. It can be managed through web UI. SDL550 supports features of maximum 16 Access Nodes connected to a Central Node. All of the Nodes are in a same wireless LAN and share the whole transmission bandwidth (maximum 30Mbps@20MHz throughput). Data from Central Node to Access Node, we call downlink, and data from Access Node to Central Node, we call uplink. Uplink and downlink stream ratio can be controlled through web UI. When using SDL550 for Point-to-Point transmitting, uplink and downlink share the whole transmission bandwidth (maximum 30Mbps@20MHz throughput) too. SDL550 supports networking mode: Point -to-Point, Point-to-Multipoint, Relay, and Mesh (specify mesh version when order).

Point-to-Point transmitting

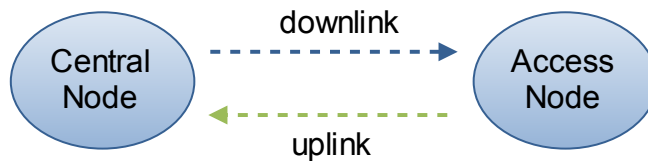

Point-to-Multipoint transmitting

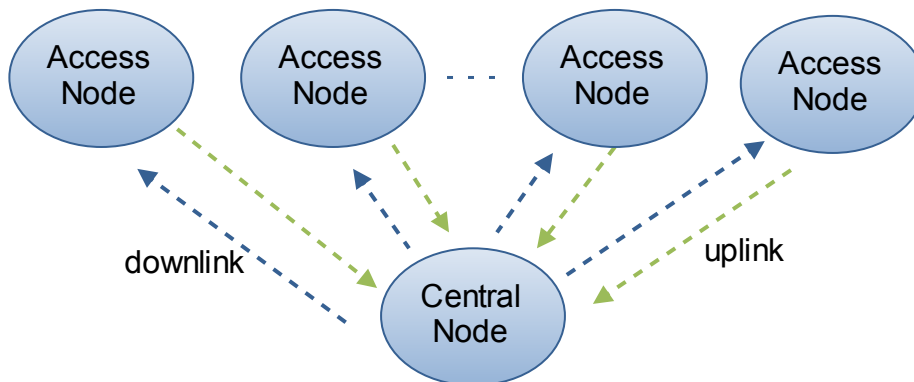

Relay transmitting

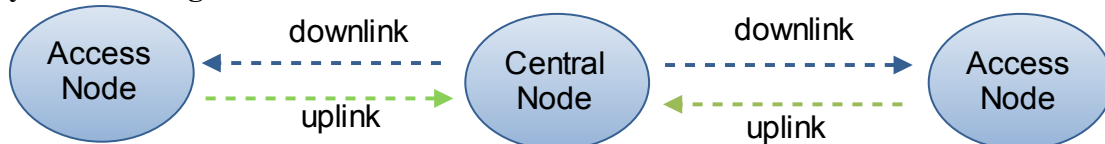

Mesh transmitting (Specify)

